

4

3

2

1

THIS DRAWING IS UNPUBLISHED. RELEASED FOR PUBLICATION 20
 © COPYRIGHT 20 BY Tyco Electronics Japan G.K. ALL RIGHTS RESERVED.

LOC	DIST	REVISIONS					
J	-	P	LTR	DESCRIPTION	DATE	DWN	APVD
			C	REVISED	15APR2014	H.O	N.Y
			D	REVISED	17JUN2014	H.O	N.Y

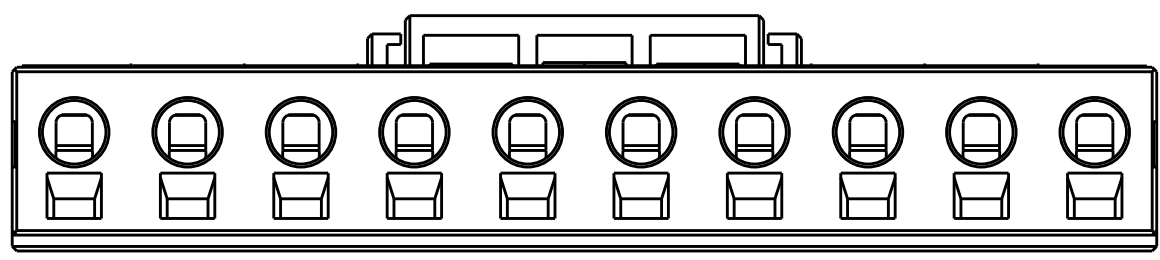

AS SHOWN : 1-2013522-0 (10POS, X-KEY)

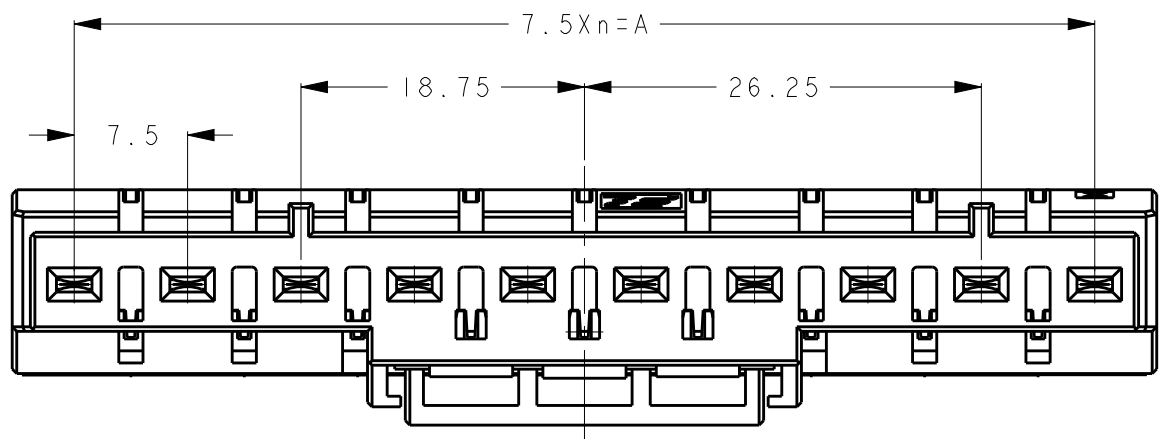
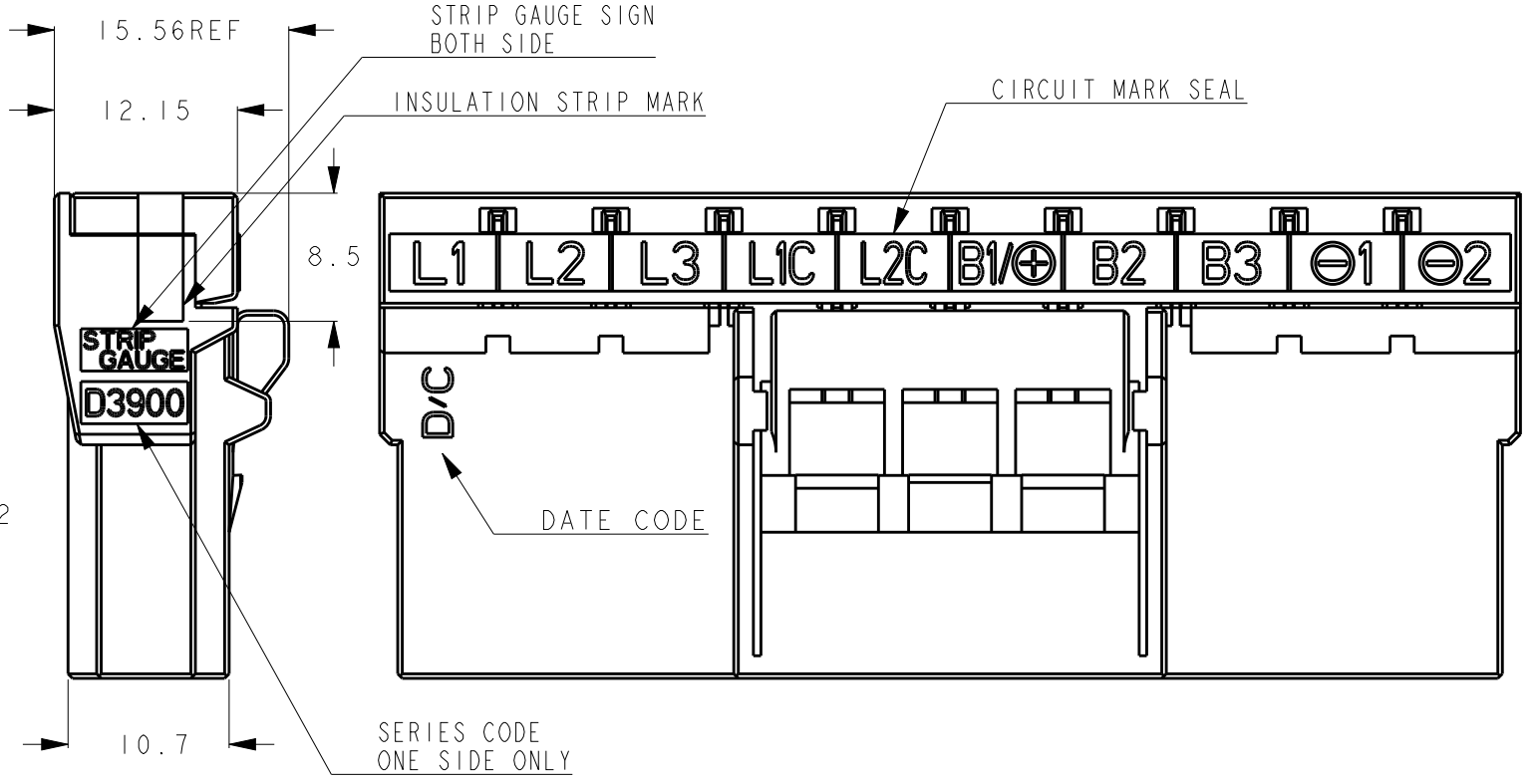
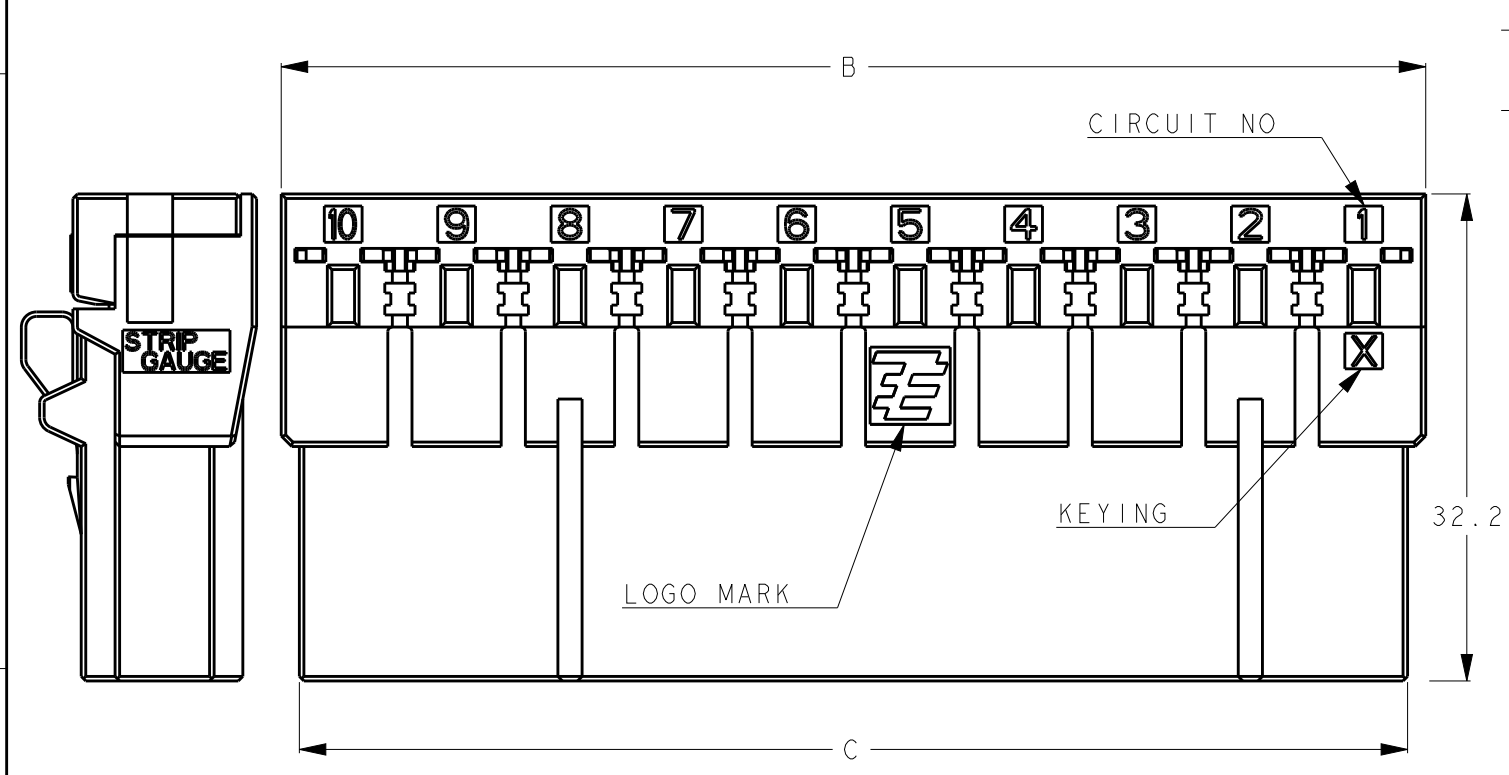

10	Y	9	67.5	75.7	73.3	BLACK	2-2013522-0
10	X	9	67.5	75.7	73.3	BLACK	1-2013522-0
7/10	Z	9	67.9	75.7	73.3	BLACK	9-2013522-0
3	Y	2	15.0	23.2	20.4	NATURAL	4-2013522-3
3	X	2	15.0	23.2	20.4	BLACK	1-2013522-3
POS	KEY	n	A	B	C	COLOR	PART NO

- 材料:ハウジング:熱可塑性ポリエステル樹脂
 コンタクト:銅合金
 スプリング:ステンレス
- めっき:(コンタクト接触部):ニッケル下地めっきの上に金めっき0.38μm以上
- 取扱説明書411-78272参照

- MATERIAL HOUSING:THERMO PLASTIC POLYESTER
 CONTACT:COPPER ALLOY
 SPRING:SUS
- FINISH(CONTACT AREA):0.38μmMIN GOLD PLATED OVER NICKEL
- SEE INSTRUCTION SHEET 411-78272

THIS DRAWING IS A CONTROLLED DOCUMENT.

DIMENSIONS: 単位: 毫 mm	TOLERANCES UNLESS OTHERWISE SPECIFIED: 一般公差 ±0.3, ±5° 0-PLC ± 1-PLC ± 2-PLC ± 3-PLC ± 4-PLC ± ANGLES ±	DWN T. KUDO 21APR2008 CHK S. MANABE 21APR2008 APVD S. MANABE 21APR2008	TE Connectivity	
MATERIAL 材料	FINISH 仕上	PRODUCT SPEC 108-78400 APPLICATION SPEC 取付適用規格	NAME 名称 DYNAMIC D3900S 7.5mmPITCH REC ASSY (SPRING CLAMP TYPE) 3-10POS TYPE-A	
CUSTOMER DRAWING		WEIGHT -	SIZE A300779	RESTRICTED TO -
		SCALE 尺度 2:1	DRAWING NO 番号 G-2013522	SHEET 1 OF 3
				REV D

THIS DRAWING IS UNPUBLISHED.

RELEASED FOR PUBLICATION

20

© COPYRIGHT 20

BY Tyco Electronics Japan G.K.

ALL RIGHTS RESERVED.

LOC J

DIST -

REVISIONS

P	LTR	DESCRIPTION	DATE	DWN	APVD
		SEE SHEET 1			

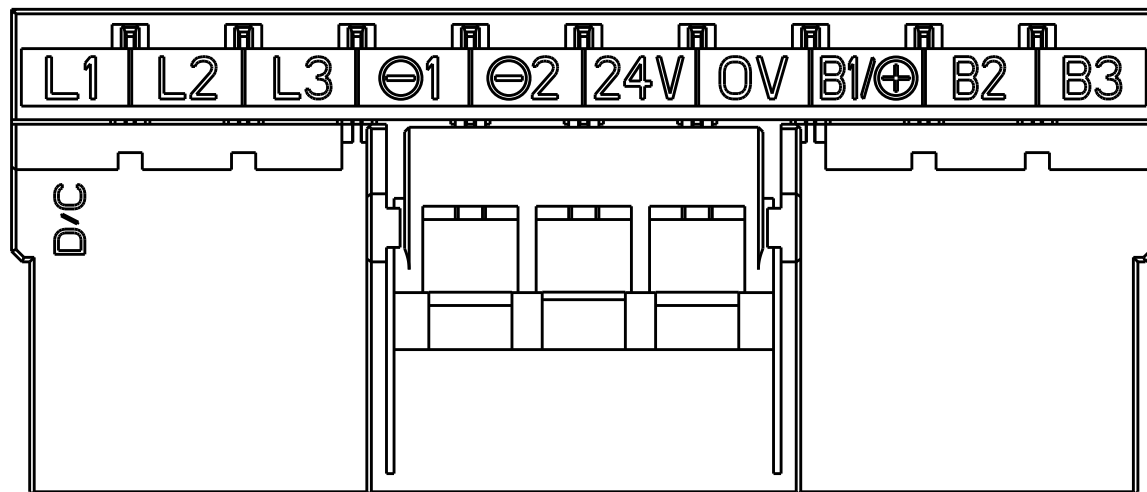

10POS(Y-KEY): 2-2013522-0

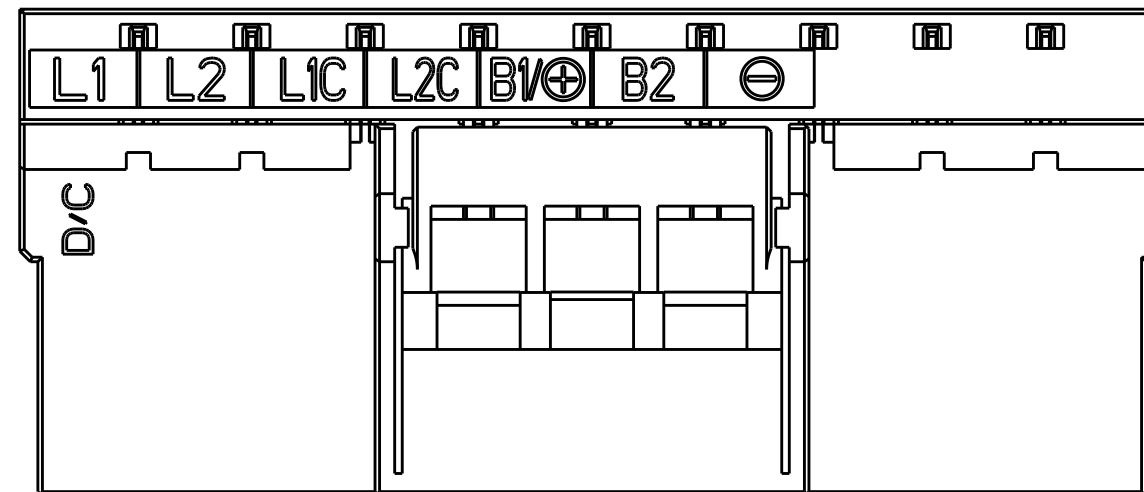

7/10POS(Z-KEY)
CIRCUIT 1~7: 9-2013522-0

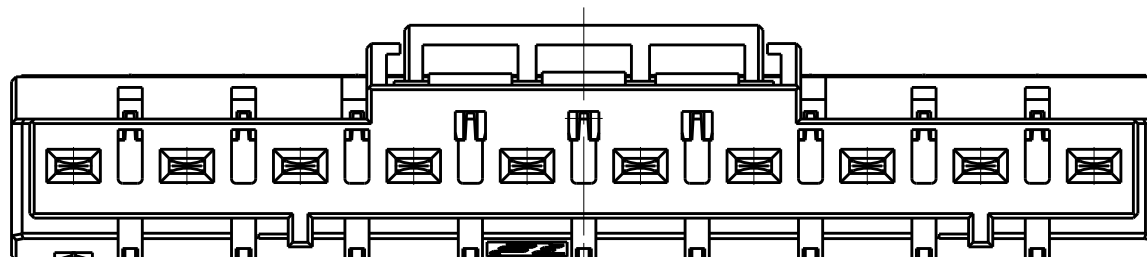

18.75 26.25

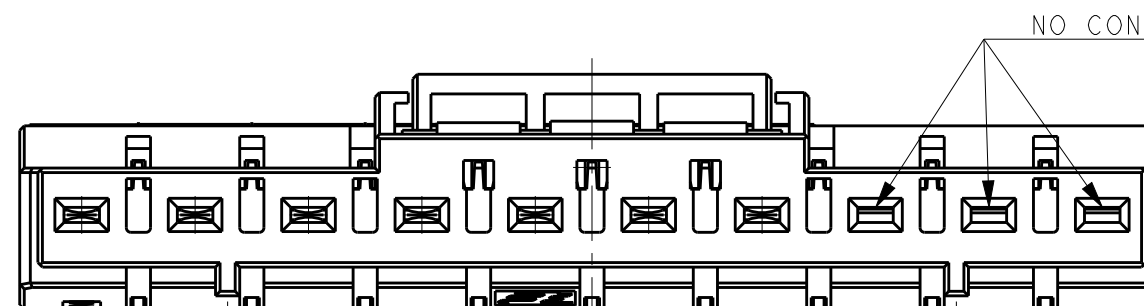

24.1 24.1

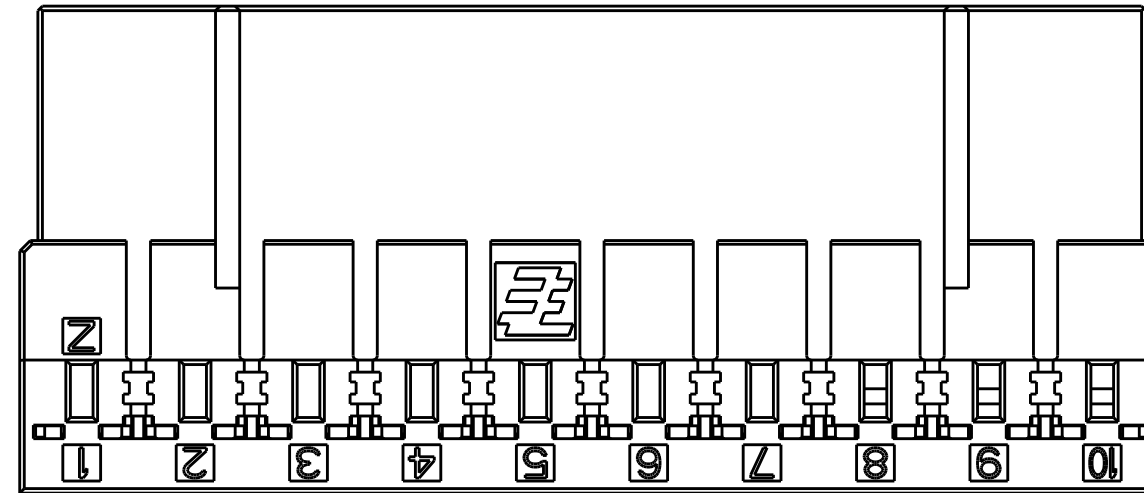
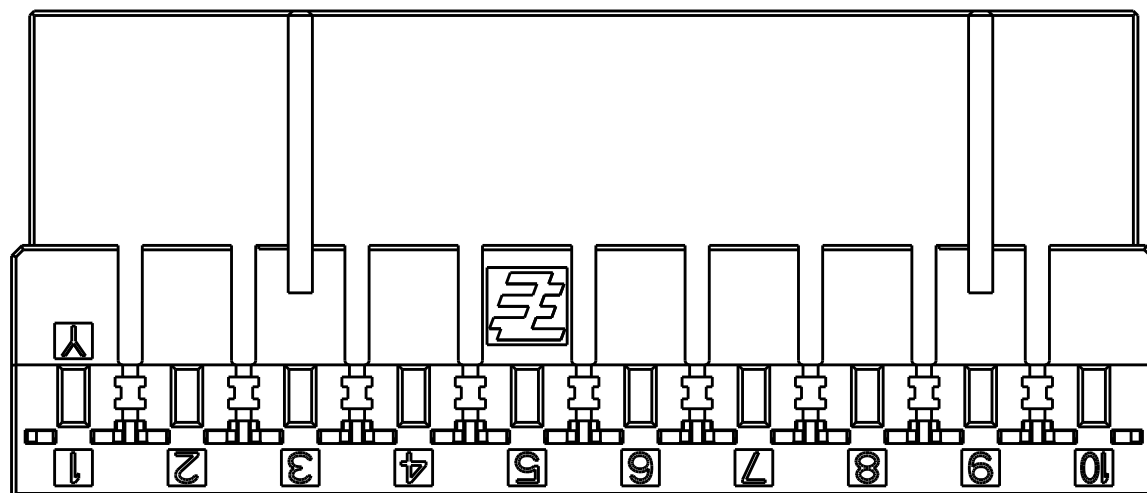

THIS DRAWING IS A CONTROLLED DOCUMENT.

DIMENSIONS:	
mm	
TOLERANCES UNLESS OTHERWISE SPECIFIED:	
0 PLC	±-
1 PLC	±-
2 PLC	±-
3 PLC	±-
4 PLC	±-
ANGLES	±-
MATERIAL	FINISH
-	-

SEE SHEET 1 OF 3

DWN	T. KUDO	21APR2008
CHK	S. MANABE	21APR2008
APVD	S. MANABE	21APR2008
PRODUCT SPEC	108-78400	
APPLICATION SPEC	-	
WEIGHT	-	



NAME			RESTRICTED TO		
DYNAMIC D3900S 7.5mmPITCH REC ASSY (SPRING CLAMP TYPE) 3-10POS TYPE-A					
SIZE	CAGE CODE	DRAWING NO			
A3	00779	C-2013522			

THIS DRAWING IS UNPUBLISHED.

RELEASED FOR PUBLICATION

20

© COPYRIGHT 20

BY Tyco Electronics Japan G.K.

ALL RIGHTS RESERVED.

LOC	DIST	REVISIONS			
P	LTR	DESCRIPTION	DATE	DWN	APVD
J	-	SEE SHEET 1			

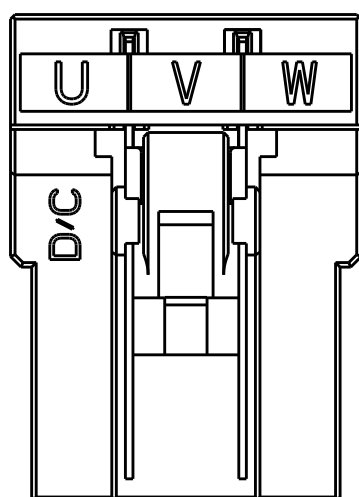

3POS(X-KEY): 1-2013522-3

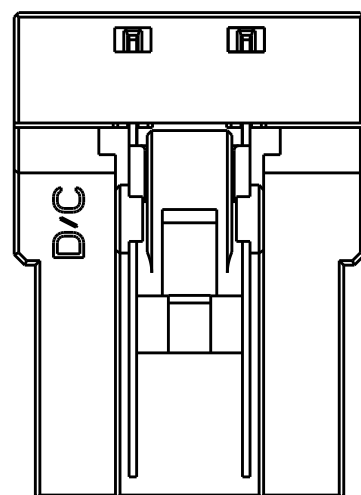

3POS(Y-KEY): 4-2013522-3

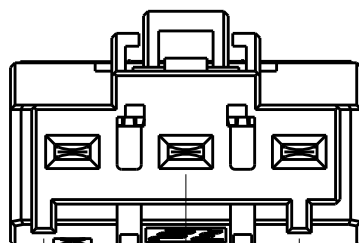

9.4 7.5

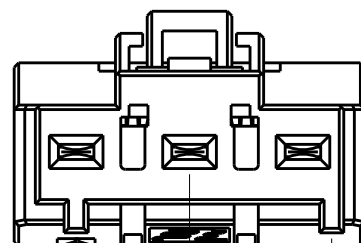

7.5 9.4

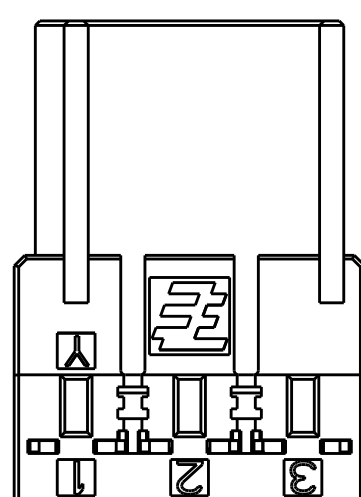
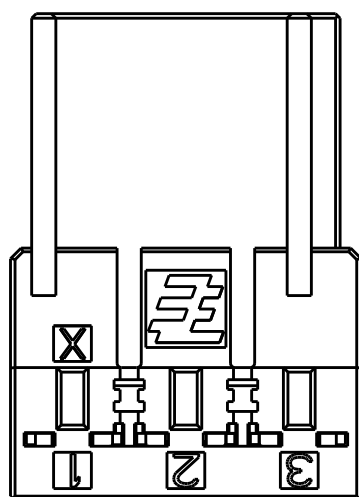

THIS DRAWING IS A CONTROLLED DOCUMENT.

SEE SHEET 1 OF 3

DIMENSIONS:	TOLERANCES UNLESS OTHERWISE SPECIFIED:
mm	
	0 PLC ±-
	1 PLC ±-
	2 PLC ±-
	3 PLC ±-
	4 PLC ±-
	ANGLES ±-
MATERIAL	FINISH
-	-

DWN	T. KUDO	21APR2008
CHK	S. MANABE	21APR2008
APVD	S. MANABE	21APR2008
PRODUCT SPEC	108-78400	
APPLICATION SPEC	-	
WEIGHT	-	
CUSTOMER DRAWING		

		TE Connectivity	
		NAME	
DYNAMIC D3900S 7.5mmPITCH REC ASSY (SPRING CLAMP TYPE) 3-10POS TYPE-A			
SIZE	CAGE CODE	DRAWING NO	RESTRICTED TO
A3	00779	C-2013522	-
SCALE		SHEET	REV
2:1		3 OF 3	D